



REVERB

• BACKLIT

ASSEMBLY INSTRUCTIONS



SET UP THE FRAME



IN THE BAG:
1x REVERB BACKWALL FRAME
1x REVERB FABRIC GRAPHIC
3x REVERB LED CURTAINS

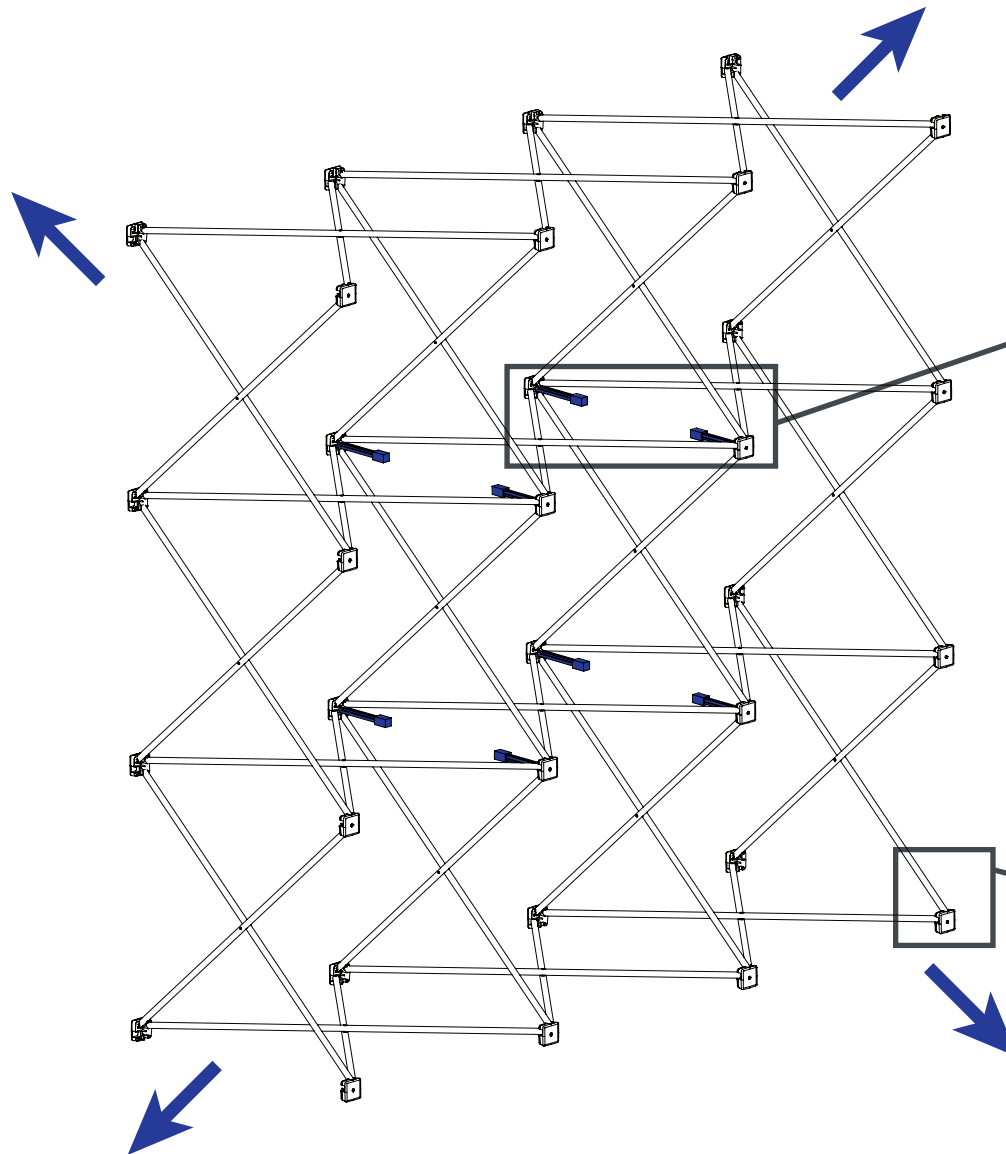

INTERNAL FRAME LOCKS

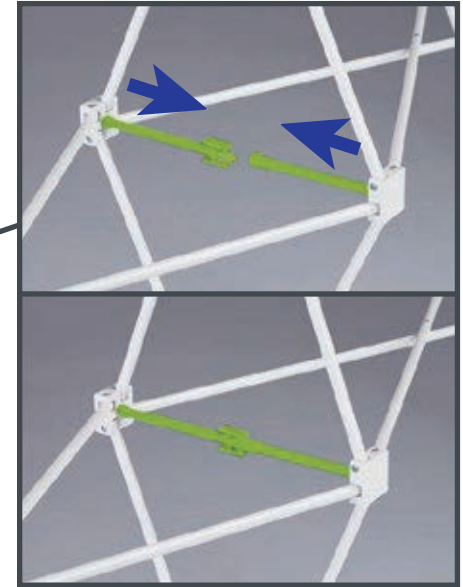

ADJUSTABLE FEET

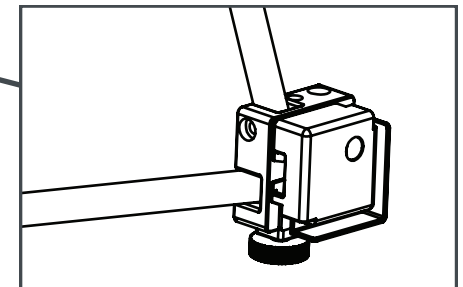

INSTALL THE CHANNEL BARS

CHANNEL BAR SET

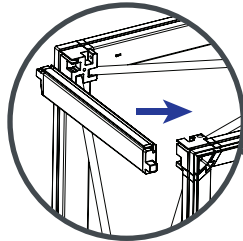

↑ SEG GROOVE
FACES UP

INTERNAL CORD DIAGRAM

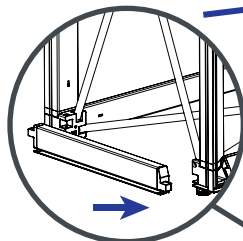
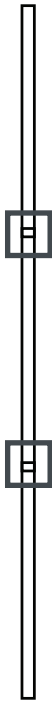
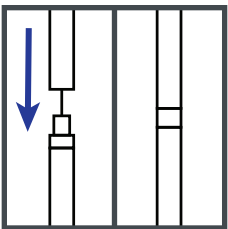

↓ SEG GROOVE
FACES DOWN

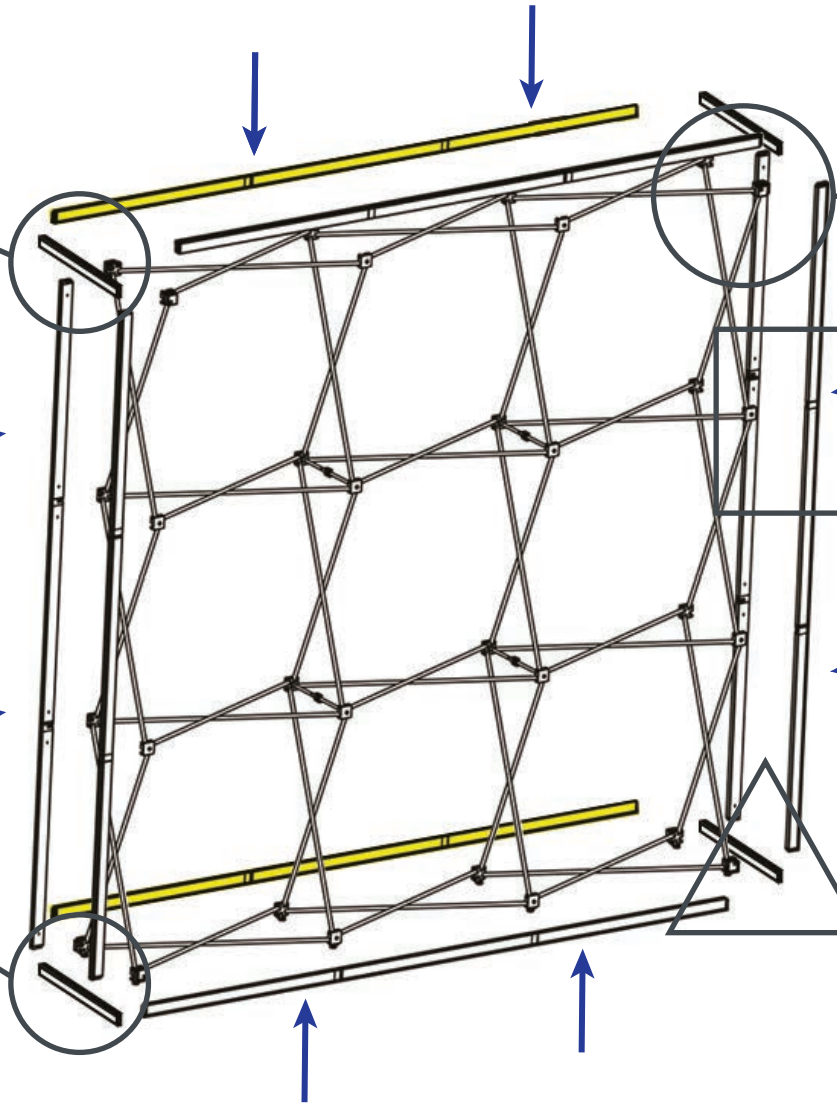

CHANNEL BAR CONNECTIONS

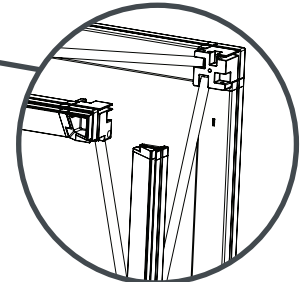

TOP CONNECTION

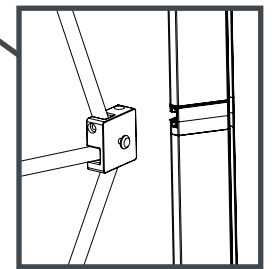

MID CONNECTION

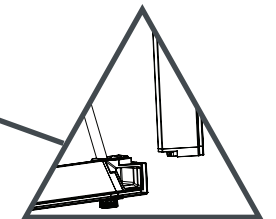

BOTTOM CONNECTION



Back horizontal channel bars are included with the backlit REVERB frames. For double-sided straight or curved REVERB, they must be ordered separately.

INSTALL THE LED CURTAINS

LED CURTAIN SET

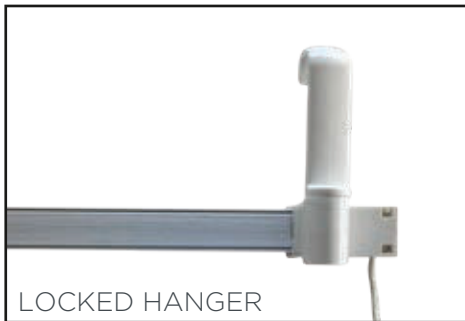
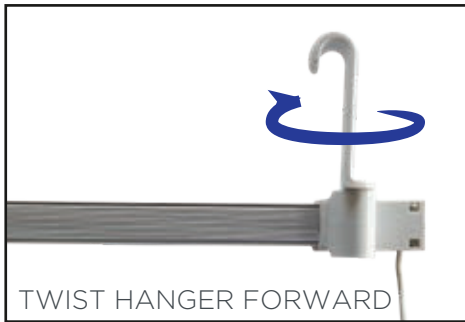

HANGER PLACEMENT
MID-FRAME DETAIL

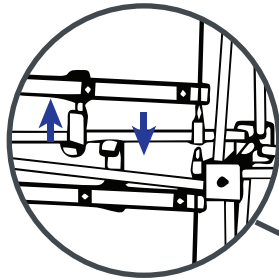

HANGER PLACEMENT
BOTTOM FRAME DETAIL

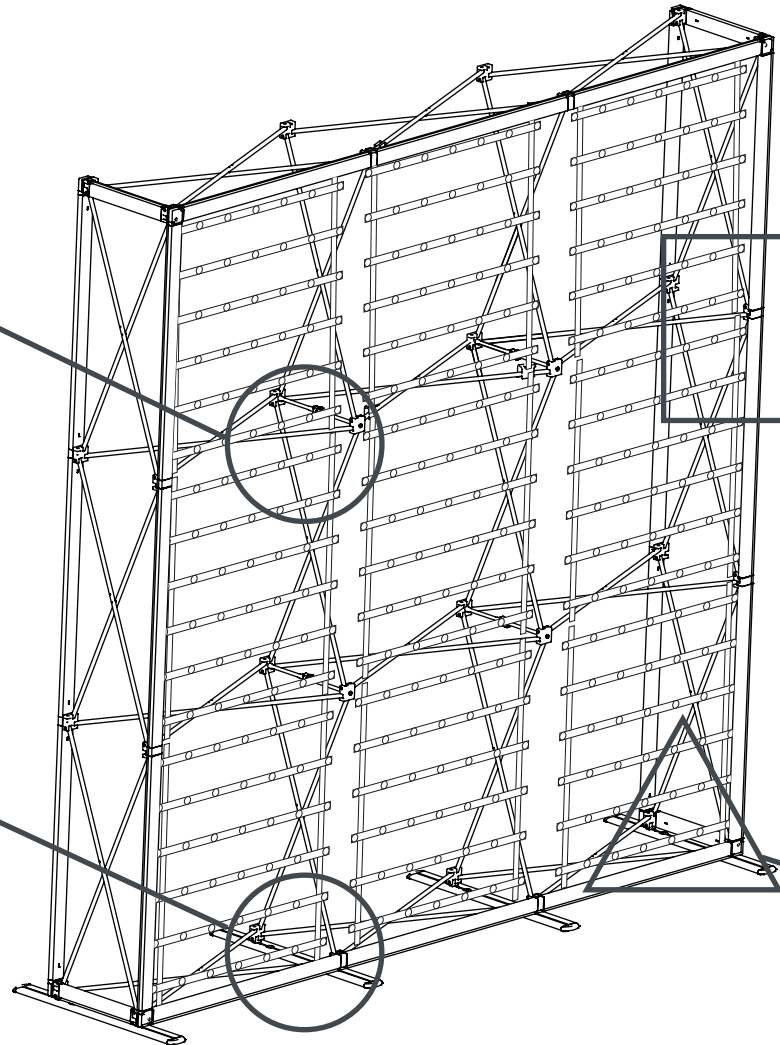
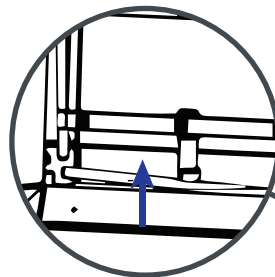

ELECTRICAL
CONNECTION

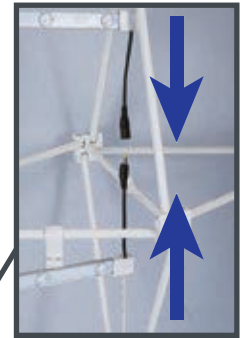

TRANSFORMER
CONNECTION



INSTALL THE GRAPHIC

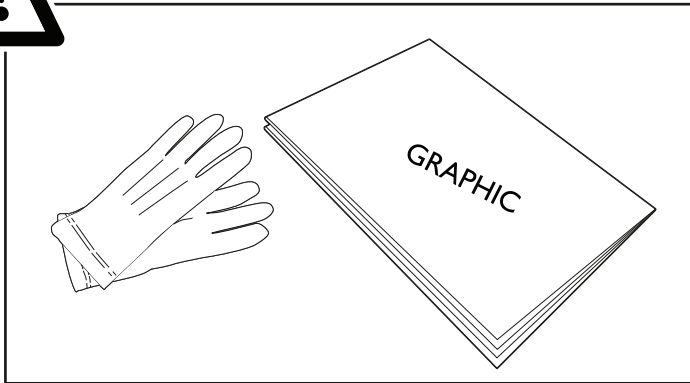

Tips: Use gloves and work on a clean site.
For curved structures, put the structure on the floor to set-up the graphic

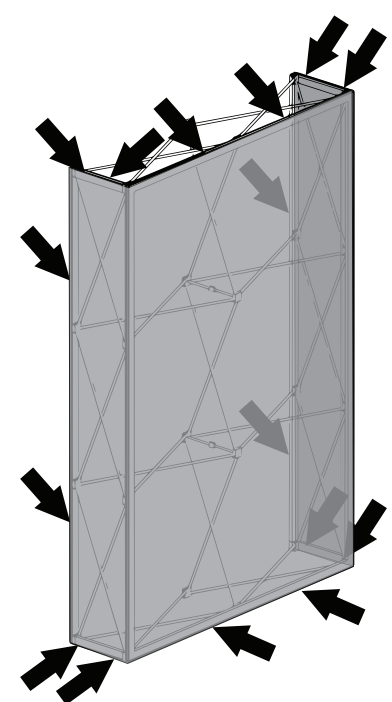
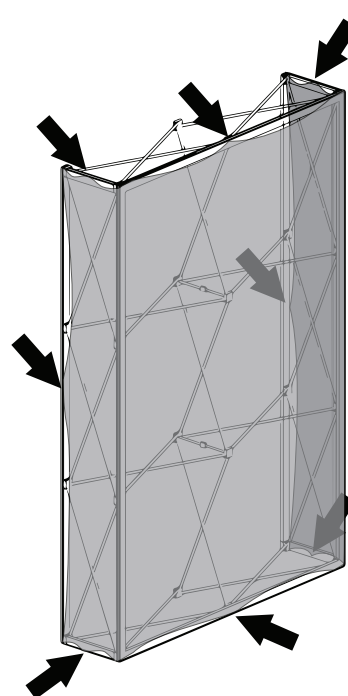
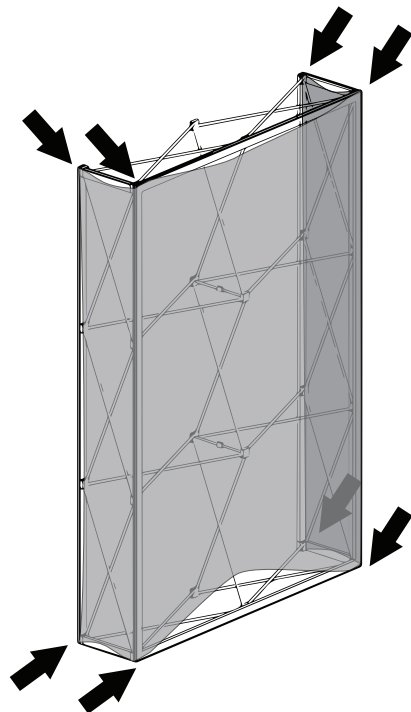
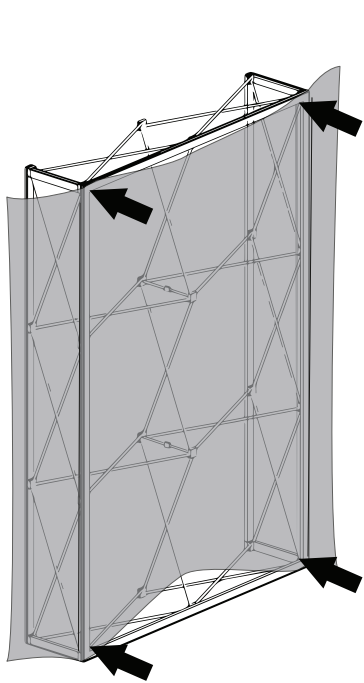
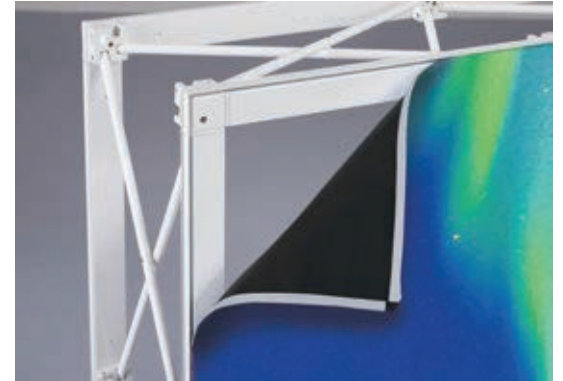

SET UP THE BACKLIT COUNTER / FRONT VIEW

1. OPEN THE FRAME AND LOCK SIDE BRACKETS

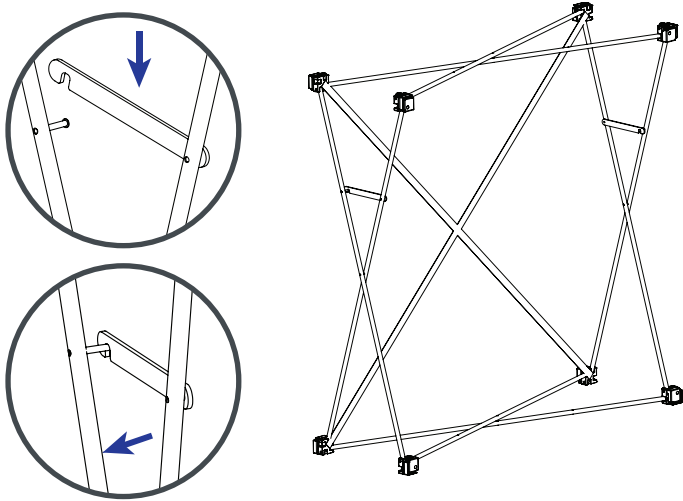

2. CONNECT OUTSIDE CHANNEL BARS

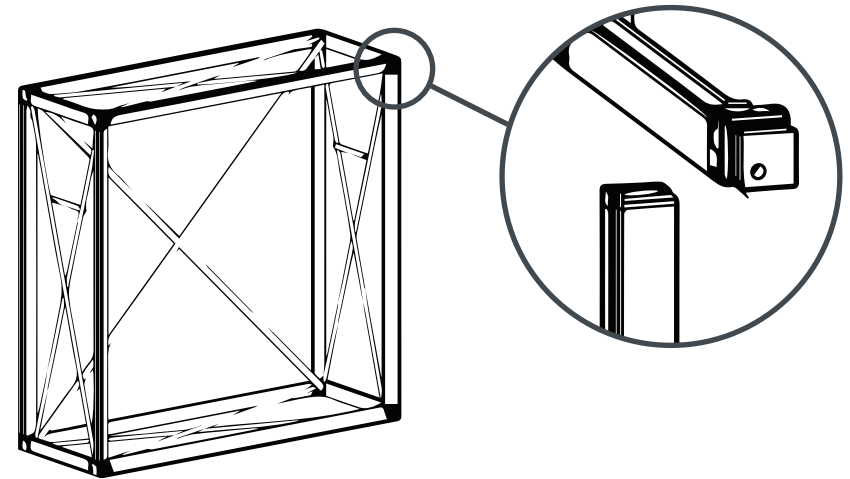

3. INSTALL LED LIGHT CURTAIN

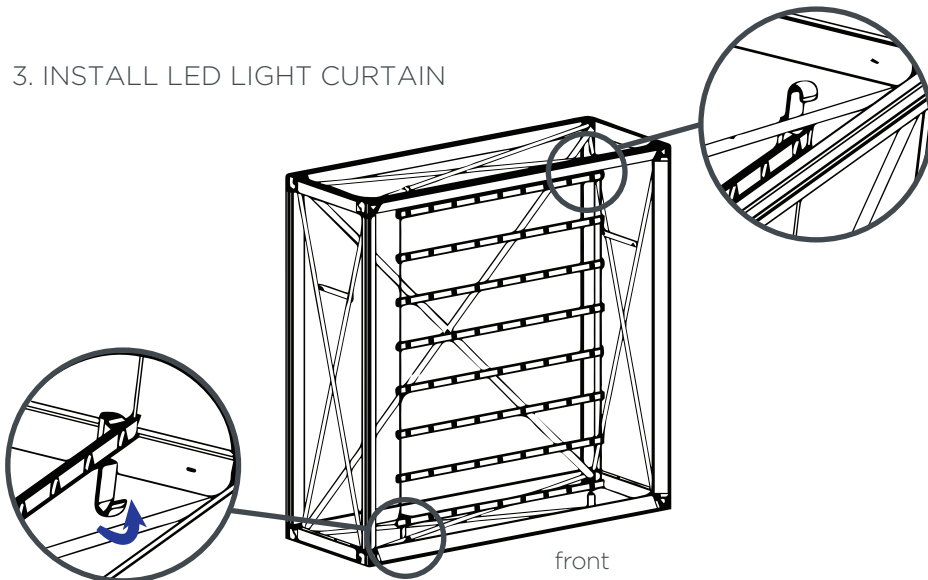

4. PLACE COUNTERTOP

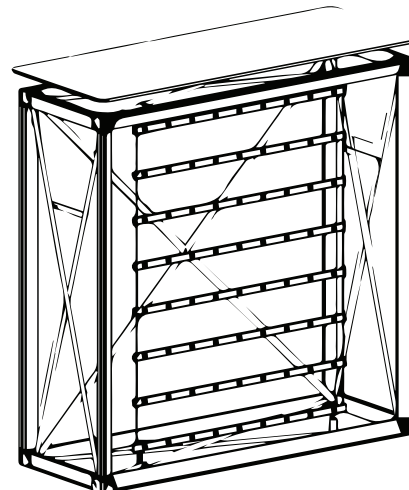

5. INSTALL FABRIC GRAPHIC

